

Shelling of the Mirny and Gayevoy residential quarters in the city of Luhansk with the use of Grad Multiple Launch Rocket Systems on July 14, 2014

PUBLIC INVESTIGATION

Donetsk 29.11.2021

Author: Ivan Aleksandrovich Kopyl

CONTENT

ABBREVIATIONS	2
PREAMBLE	3
INCIDENT LOCATION	4
WEAPON TYPE.....	7
Testimonies and physical evidence.....	7
BM-21 Grad MLRS	7
PROBABLE SECTOR OF SHELLING.....	8
Direction.....	8
The shelling sector	9
MILITARY PRESENCE	10
Units in the sector	10
The 1st Severia Tank Brigade (Ukraine)	11
Persons in charge	12
CONCLUSIONS	13
LEGAL QUALIFICATIONS	14
REFERENCES.....	16
Sources used in the text.....	16
Additional sources.....	19
ANNEXES	25

ABBREVIATIONS

UAF - Ukrainian Armed Formations

UGF - Ukrainian Ground Forces

STBr - Severia Tank Brigade

MLRS - Multiple Launch Rocket System

MM – mass media

MP – missile part

PREAMBLE

On July 13 and 14, 2014, the Ukrainian armed formations (UAF) attempted to unblock the Luhansk Airport¹. The attack was directed from Slavyanoserbsk, along the western outskirts of Luhansk. During this operation, Luhansk was subjected to massive shelling, **civilians were killed and injured**, infrastructure facilities were damaged, civilian objects were destroyed and damaged².

On July 14, 2014, as a result of artillery shelling of the city of Luhansk, at least 8 civilians were killed and 52 civilians were injured³.

This investigation will consider the shelling with the use of BM-21 Grad MLRS, which took place on July 14, 2014 at about 18:00. In the course of this incident, residential buildings were damaged in the Mirny and Gayevoy quarters. The list of the victims formed from citizens' messages was published on the Internet⁴. The names of civilians who were killed in this incident can be found there. This list (Fig. 1) contains the names of persons killed on July 14:

1. Nikolay Bakhmach, ... - 14.07.2014
2. Sergey Petrovich Bober, 09.11.1958 - 14.07.2014
3. Alla Logacheva, 23.06.1976 - 14.07.2014

This list does not include information about an unknown young man who was killed at the "Vtorchermet" public transport stop located to the south of the residential building at 77, Andrey Linyov St., Luhansk (according to photo/video materials).

¹ An attempt of the Armed Forces of Ukraine to break through into the Luhansk airport on July 13-14, 2014. YouTube Video hosting. URL: <https://youtu.be/MDEtm1SgyYU> (accessed on 29.11.2021).

² Luhansk on July, 14 2014. Shelling of the city with MLRS. Antimaydan website. URL: https://antimaydan.info/2018/07/Luhansk_14_iulya_2014_obstrel_goroda_iz_rszo.html (accessed on 29.11.2021).

³ We remember! How Luhansk was shot. July 2014. LiveJournal Online Journal Service. URL: <https://kot-sapog.livejournal.com/9104932.html> (accessed on 29.11.2021).

Luhansk quarters - Mirny and Gayevoy fell under the GRAD. PHOTO. VIDEO [published on 15.07.2014] MigNews URL: <https://mignews.com.ua/sobitiya/inukraine/3242109.html> (accessed on 29.11.2021).

⁴ The list of the dead. Google documents. URL: https://docs.google.com/spreadsheets/d/1IWV5AOyexGzrz1xCrP4H_Sj-Nvr3kKyq98CVKR08XAA/edit#gid=306722867 (accessed on 29.11.2021).

INCIDENT LOCATION

Studies of the photo and video materials published in the media and on the Internet, and testimony of the eyewitnesses of the artillery shelling of Luhansk on July 14, 2014, at about 18:00 enabled us to establish fourteen locations of artillery shell hits (see Fig. 2, Fig. 3). It is worth noting that we considered only those hits for which there is sufficient information to refer them to the time and place of the shelling. It should be emphasized that there were more such hits, proceeding from the eyewitnesses' testimony.

Shell hit 1 (see Fig. 4, see Fig. 5). The shell hit the lawn between the residential building at 2, Mirny quarter, Luhansk, and the "Karefan" café at 2 litZ, Mirny quarter. As a result of the detonation of this projectile, fatal injuries caused by shell fragments were received by a young mother who was walking with a child and Nikolai Bakhmach⁵.

Shell hit 2 (see Fig. 6). The shell hit the territory of the parking lot, which is adjacent to the north side of the "Karefan" café. As a result of the projectile detonation, several motor vehicles started burning.

Shell hit 3 (see Fig. 7, see Fig. 8) A shell hit the northern wall of a multi-storey residential building at the address 6, Stepnoy quarter, Luhansk, at the second-floor level. As a result of the projectile detonation, a through hole was formed in the wall of the building.

Shell hit 4 (see Fig. 9, see Fig. 10, see Fig. 11) A shell hit the northern wall of a multi-storey residential building at the address 16, Stepnoy quarter, Luhansk, at the second-floor level. As a result of the projectile detonation, a through hole was formed in the wall of the building.

Shell hit 5 (see

⁵ 14.07.2014. News item of LifeNews Information Channel [published on 15.07.2014] VKontakte Social Network. URL:https://vk.com/wall-61706629_55971 (accessed on 29.11.2021).

Fig. 12). A shell hit the road pavement at the exit from Andrey Linyov Street, opposite the western end of the residential building at 79A, Andrey Linyov St, Luhansk. The projectile detonation resulted in a shell crater.

Shell hit 6 (see Fig. 13) A shell hit a lawn a few meters from the south-western corner of a multi-storey residential building at 79A, Andrey Linyov St, Luhansk. The projectile detonation resulted in a shell crater.

Shell hit 7 (see Fig. 14) A shell hit the curb of the sidewalk between residential buildings at 85A, Andrey Linyov St. and 81, Andrey Linyov St. The projectile detonation resulted in a shell crater.

Shell hit 8 (see Fig. 15, see Fig. 16) A shell hit the ground a few meters north of the residential building at 79A, Andrey Linyov St., Luhansk between 1 and 2 entrance halls. The projectile detonation resulted in a shell crater in the yard.

Shell hit 9 (see Fig. 17) A shell hit the northern wall of the two-storey residential building at 75L, Andrey Linyov St., Luhansk, at the level of the 1st floor. As a result of the projectile detonation, a through hole was formed in the wall of the building.

Shell hit 10 (see Fig. 18, see Fig. 19, see Fig. 20) A shell hit a curb in the northern part of the road next to the “Vtorchermet” public transport stop, which is located to the south of the residential building at 77, Andrey Linyov St., Luhansk. As a result of the projectile detonation an unknown man was killed at a public transport stop, and a crater was formed in the curb stone.

Shell hit 11 (see Fig. 21, see Fig. 22, see Fig. 23) A shell hit the asphalt pavement nearby garages. A crater was formed 45 meters south of the south-east corner of the building at 75M, Andrey Linyov St., Luhansk.

Shell hit 12 (see Fig. 24, see Fig. 25) A shell hit the car parking lot to the west of the residential building at 3G, Timiryazev St., Luhansk. As a result of the projectile detonation, several motor vehicles started burning.

Shell hit 13 (see Fig. 26, see Fig. 27, see Fig. 28) A shell hit the roof of the utility premises located to the north of the building at the address 75 lit. Z, Andrey Linyov St., Luhansk. As a result of the projectile detonation, a through hole was formed in the roof.

Shell hit 14 (see Fig. 29, see Fig. 30) A shell hit the road pavement about 25 meters from the south-western corner of the building at 3G, Timiryazev St., Luhansk. The projectile detonation resulted in a shell crater.

WEAPON TYPE

Testimonies and physical evidence

In all the shell hit sites under consideration, the debris of the missile parts of the MLRS projectiles were found. In cases of shell hits 12 and 13 (see Fig. 31 and Fig. 32) the MP debris were found with the shape of holes for tail fin fastening that are typical for the BM-21 Grad MLRS⁶.

In addition, the Grad MLRS rockets are characterized by the presence of 7 nozzles (see Fig. 33) as opposed to one nozzle on the Smerch MLRS and Uragan MLRS missiles (see Fig. 34 and Fig. 35).

Thus, the MP debris with characteristic seven nozzles were found at the sites of shell hits 13 and 14 (see Fig. 30 и Fig. 31).

All the above facts give us grounds to assert that the shelling under consideration in this investigation was carried out using the BM-21 Grad MLRS.

BM-21 Grad MLRS

The projectile for firing from 9K51 Grad MLRS consists of a fuze, head and rocket parts. As a result of contact with an obstacle, the detonator initiates an explosion of the shell head, which scatters into fragments. The rocket often remains more or less intact, though deformed. It is usually found either inside the shell crater, or in the immediate vicinity of it. For clarity, we present the design and technical characteristics of the most common projectile used for firing from the 9K51 Grad MLRS (see Fig. 36).

⁶ For a more detailed description of the characteristic form of fastening of the BM-21 Grad rocket tail fins, see the investigation "Shelling of the city of Makeyevka with the use of BM-21 Grad multiple launch rocket systems on August 19, 2014". URL: <https://lostarmour.info/articles/obstrel-goroda-makeevka-s-primeneniem-sistem-zalpovogo-ognya-bm-21-grad-19-avgusta-2014-goda/>

PROBABLE SECTOR OF SHELLING

Direction

In case of shell hit 4 the projectile hit the north wall of the building. Moreover, damage from shell fragments left on the wall indicates that the intersection of the building wall plane and the plane of the main scatter of fragments formed an almost horizontal line (see Fig. 38). This suggests that the projectile flew in a direction close to perpendicular to the wall. Considering that building No. 16 in the Olkhovsky residential quarter is oriented strictly to the north, it can be argued that in this case the projectile flew from north to south (see Fig. 39).

Shell hit 13 has a well-defined shape and corresponds to a shell crater being in contact with the surface at a low striking angle without delayed detonation (see Fig. 40). The shape of such craters forms a kind of an arrow that points to the gun (see Fig. 41).

This shell hit is clearly visible in the satellite image and enables to determine the shelling direction (see Fig. 42). As in the previous case, the shelling was carried out in the direction from north to south.

It should be noted that in the event of shell hit 9, the damage also occurred on the northern wall of the building at 75L, Andrey Linyov St. And shell hit 8 happened near the northern wall of the residential building at 79A, Andrey Linyov St.

In addition, in the case of shell hit 10, the trail from the main scatter of fragments is observed on the north side of the curb, which was hit by the projectile (see Fig. 43), which indicates the projectile flight direction from north to south.

Considering that, according to eyewitness accounts, all the hits we are considering occurred at the same time and, as will be shown below, using the same type of artillery piece, it can be argued that all the shells flew from north to south.

The shelling sector

The firing range of the BM-21 Grad MLRS using the most common types of unguided Soviet-made high-explosive fragmentation projectiles (M-21OF) does not exceed 20.1 km⁷.

In addition, social networks posted a detailed description of the situation that was developed these days on the line of contact⁸. And also, there is a map of battles conducted on July 13 and 14, 2014 (see Fig. 1).

By mapping a sector that considers the minimum and maximum firing range, the fire direction azimuth with regard to the error of plus or minus 15 degrees, and the demarcation line, we will get a visual representation of the terrain from which Luhansk was fired on July 14, 2014 (see Fig. 45).

This sector has the shape of a truncated triangle with corners: Vesna garden plots – the village of Pankovka – Artyomovsky District of Luhansk – the intersection of Kirov, A. Lunev and Ukrainskaya Streets in Luhansk. The sector goes deep into the territory controlled by the armed formations of the LPR for about 3 km. It should be noted that usually Grad MLRS units are placed no closer than 3-4 km from the zone of active hostilities (not to risk unnecessarily valuable equipment).

For this reason, it is worth considering the part of the sector to the north of the Metallist village most carefully.

⁷ M-21OF 122 mm unguided high-explosive fragmentation projectile (ind. 9M22U) Rosoboronexport website. URL: <https://roe.ru/catalog/sukhoputnye-vosyka/boepripasy/m-21of/> (accessed on 29.11.2021).

⁸ "Grad" MLRS: history and performance characteristics. LiveJournal Online Journal Service. URL: <https://sobolev-sv.livejournal.com/535544.html> (accessed on 29.11.2021).

MILITARY PRESENCE

Units in the sector

On August 19, 2014, the Ukrainian TV channel “Hromadske Telebachennya” broadcast a taped news item titled “Luhansk under siege. Veselaya Gora”⁹. As follows from the video plot subtitles, it was filmed on August 18, 2014.

The video shows the servicemen of the 1st Tank Brigade (1-st TBr) of the Ukrainian Ground Forces. In the second minute, a soldier named Dmitry says that they have been in positions for more than a month. Thus, it can be stated that on July 14, 2014, a base camp of the 1st TBr was located in the vicinity of Veselaya Gora settlement. Moreover, this base camp is clearly visible in the satellite image dated July 17, 2014 (see Fig. 46).

According to the Ukrainian version of Wikipedia, the brigade has a rocket artillery battalion¹⁰. This fact is confirmed by the above video, where at the 7th minute three Ukrainian BM-21 Grad MLRSs appear in the frame, that fired towards Luhansk from combat positions (see Fig. 47). From further viewing the video, it becomes clear that these MLRS units are part of the 1st TBr.

In addition, the satellite image dated July 17, 2014, shows three patches of burnt earth in the vicinity of Stukalova Balka settlement. These patches are very similar to the traces that remain after the launch of missiles from MLRS. Also, in the field to the north of these patches, there are traces of vehicles moving towards them (see Fig. 48).

It can be assumed that from the base camp near Veselaya Gora settlement, the Grad MLRS battery was emplaced toward Stukalova Balka settlement to support the attack on the Luhansk airport.

⁹ Luhansk under siege. Vesela Gora [published on 01.10.2014] YouTube Video hosting. URL: <https://youtu.be/uuVS4gkq5tE> (accessed on 29.11.2021).

¹⁰ 1st Tank Brigade (Ukraine). Wikipedia. [https://en.wikipedia.org/wiki/1st_Tank_Brigade_\(Ukraine\)](https://en.wikipedia.org/wiki/1st_Tank_Brigade_(Ukraine)) (accessed on 29.11.2021).

Thus, it can be argued that on July 14, 2014, there was a rocket artillery battalion of the 1st Tank Brigade in the sector from which the shelling of Luhansk was carried out with the use of the BM-21 Grad MLRS.

The 1st Severia Tank Brigade (Ukraine)

The 1st Severia Tank Brigade was created in 1997 in the Honcharivske settlement on the basis of the 292nd Guards Armored Regiment of the 72nd Mechanized Division and 280th Armored Regiment of the 25th Mechanized Division. It was granted the Severia honorific on August 24, 2017 (see Fig. 49).

As of the beginning of 2014, the 1st TBr had all three battalions authorized on establishment: The 1st and 3rd battalions equipped with the T-64BM Bulat tanks and 2nd battalion equipped with T-64 tanks of various modifications: B, BM2, BV. In total, there are 125 tanks, of which 82 are relatively new Bulats. In addition, the brigade had a lot (several company kits) of non-organic tanks assembled here from disbanded units (at least from the 128th Separate Mountain Assault Brigade).

By the way, this made it possible at the end of 2014 to form two separate tank battalions as part of the 169th Training Center and compensate for combat losses during the war.

Apart from tank battalions, the brigade also included a mechanized battalion, a brigade artillery group, an anti-aircraft missile division (two 2S6 Tunguska batteries) and a **rocket artillery division** (BM-21 Grad)¹¹.

In the spring of 2014, the Brigade was emplaced to the border with Russia¹². By the beginning of July 2014, the 1st TBr was transferred to the Luhansk direction. Luhansk airport was the first combat mission of the Brigade. The Tank Brigade

¹¹ News of the Donetsk Region (Donbass) and Ukraine on February 11, 2017. Donbass info website. URL: <https://donbass-info.com/content/view/34654/34665/> (accessed on 29.11.2021).

¹² "Sobol" (Sable) was first to call forth [archived version] Facebook Social Network. URL: <https://archive.vn/UdrGf#selection-447.0-447.290> (accessed on 29.11.2021).

supported the 24th, 30th, 128th mechanized brigades, 80th airmobile brigade and Aidar battalion with tanks and artillery¹³.

Persons in charge

From 2008 to 2015, the general command of the 1st TBr was carried out by Colonel Andrey Nikolaevych Gritskov¹⁴. Precisely he is responsible for the actions of his subordinates at the front (see Fig. 50).

In addition, in the above video, several people appear in the frame, who could be directly related to this artillery shelling of Luhansk. These are the operating platoon commander of the 1st TBr, Lieutenant Chepiga (see Fig. 51) and servicemen of the 1st TBr Stanislav and Sergey (see Fig. 52). Also, the video features some other persons from among the Grad MLRS maintenance squad, whose names were not mentioned.

¹³ That's what it is, babies. Livejournal URL: <https://evgenuss.livejournal.com/160188.html> (accessed on 29.11.2021).

¹⁴ Those who look the death in the eye. Gorod URL: <https://www.gorod.cn.ua/news/gorod-i-region/59109-ti-hto-divitsja-smerti-v-ochi.html> (accessed on 29.11.2021).

CONCLUSIONS

Proceeding from the above, it can be summarized that on July 14, 2014 at about 18:00 local time, the Mirny and Gayevy residential quarters of Luhansk were fired upon using the Grad MLRS. The detonation of shells in these residential quarters resulted in deaths of at least four and injuries of dozens of civilians. The 122 mm rocket projectiles flew from north to south.

As a result of the analysis of news videos and information from the Internet, it was found that the units of the 1st Tank Brigade of the Armed Forces of Ukraine were located in the sector from which the shelling was carried out on July 14, 2021. The shelling could be carried out from positions in the vicinity of Stukalova Balka settlement.

The commander of the 1st Severia TBr, Colonel Andrey Nikolaevych Gritskov undertook the general command of this unit. Also, the commander of the 1st TBr operating platoon, Lieutenant Chepiga (first name is known) and servicemen of the 1st TBr Stanislav and Sergei (surnames are not known) could be involved in the shelling of the city of Luhansk in question directly at the positions.

LEGAL QUALIFICATIONS

Indiscriminate shelling of a densely populated residential area, in which civilians were killed and injured, is a crime for which responsibility is provided by the norms of national legislation of Ukraine and by the norms of international law.

In compliance with **Art. 438 of the Criminal Code of Ukraine**, for “... use of methods of the warfare prohibited by international instruments, or any other violations of rules of the warfare recognized by international instruments consented to be binding by the Verkhovna Rada (Parliament) of Ukraine, and also giving an order to commit any such actions”, shall be punishable by imprisonment for a term of eight to twelve years., and if he same acts accompanied with an intended murder, shall be punishable by imprisonment for a term of ten to fifteen years, or life imprisonment.

In compliance with **Art. 13 of Additional Protocol II to the Geneva Conventions** of 12 August 1949, concerning the protection of victims of armed conflicts of a non-international character, dated 8 June 1977: “The civilian population as such, as well as individual civilians, shall not be the object of attack. Acts or threats of violence the primary purpose of which is to spread terror among the civilian population are prohibited”.

In compliance with **Rule 71 of Customary International Humanitarian Law** (Volume 1, ICRC, 2006): “States must never make civilians the object of attack and must consequently never use weapons that are incapable of distinguishing between civilian and military targets”

“The use of weapons which are by nature indiscriminate is prohibited”.

In compliance with Common **Art. 3 of the Geneva Conventions** of 12 August 1949 extending its effect to non-international armed conflicts “persons taking no active part in the hostilities, including members of armed forces who have laid down their arms and those placed ' hors de combat ' by sickness, wounds, detention, or any other cause, shall in all circumstances be treated humanely, without any adverse distinction founded on race, colour, religion or faith, sex, birth or wealth, or any other similar criteria”.

To this end, the following acts are and shall remain prohibited at any time and in any place whatsoever with respect to the above-mentioned persons: violence to life and person, in particular murder of all kinds, mutilation, cruel treatment and torture.

REFERENCES

Sources used in the text

1. #Luhansk. Home of Nature. (Between an agricultural farm and Gayevoy residential quarter [published on 14.07.2014] VKontakte Social Network. URL: https://vk.com/wall-61706629?day=14072014&w=wall-61706629_54059 (accessed on 29.11.2021).
2. News of the Donetsk Region (Donbass) and Ukraine on February 11, 2017. Donbass info website. URL: <https://donbass-info.com/content/view/34654/34665/> (accessed on 29.11.2021).
3. “Sobol” (Sable) was first to call forth [archived version] Facebook Social Network. URL: <https://archive.vn/UdrGf#selection-447.0-447.290> (accessed on 29.11.2021).
4. 14.07.2014. News item of LifeNews Information Channel [published on 15.07.2014] VKontakte Social Network. URL: https://vk.com/wall-61706629_55971 (accessed on 29.11.2021).
5. 1st Tank Brigade (Ukraine). Wikipedia. [https://en.wikipedia.org/wiki/1st_Tank_Brigade_\(Ukraine\)](https://en.wikipedia.org/wiki/1st_Tank_Brigade_(Ukraine)) (accessed on 29.11.2021).
6. Gun in Russia – BM-21 GRAD. Russian motor books 2002. 37 p.
7. High-explosive fragmentation shell crater analysis. "Fair Defense" Public Organization. URL: <https://oosz.su/node/42> (accessed on 27.11.2021).
8. Mechanized combat vehicle BM-21. Technical description. Book 1. Moscow: Voenizdat, 1971. Pp. 7, 8, 91; Mechanized combat vehicle BM-21. Technical description and operating instructions manual 3rd edn, stereotyped. Moscow: Armament. Politics. Conversion, 2002. Pp. 5-6.
 - a. Rocket Artillery Munitions. Missilery website. URL: <https://missilery.info/article/ram> (accessed on 29.11.2021).
9. That’s what it is, babies. Livejournal URL: <https://evgenuss.livejournal.com/160188.html> (accessed on 29.11.2021).

10. Gayevoy residential quarter, 14/07.2014. [published on 15.07.2014] VKontakte Social Network. URL: https://vk.com/wall-61706629?day=16072014&w=wall-61706629_56550 (accessed on 29.11.2021).
11. Luhansk on July, 14. Shelling of Vtorchermet 18+ [published on 15.07.2014] VKontakte Social Network. URL: https://vk.com/wall-61706629_57777 (accessed on 29.11.2021).
12. Luhansk on 14.07.2014, Linyova St. Shelling with Grad (consequences) [published on 10.10.2014] VKontakte Social Network. URL: https://vk.com/video7456796_170241910 (accessed on 29.11.2021).
13. LUHANSK AFTER THE SHELLING ON 14.07.2014. (VIDEO). [published on 16.07.2014] Liveinternet URL: <https://www.liveinternet.ru/users/natashinka57/post331058644/> (accessed on 29.11.2021)
14. Luhansk on July, 14 2014. Shelling of the city with MLRS. Antimaydan website. URL: https://antimaydan.info/2018/07/Luhansk_14_iulya_2014_obstrel_goroda_iz_rszo.html (accessed on 29.11.2021)
15. Luhansk, Olkhovsky residential quarter [published on 16.07.2014] Odnoklassniki Social Network. URL: <https://ok.ru/video/2331316729> (accessed on 29.11.2021)
16. Luhansk under siege. Vesela Gora [published on 01.10.2014] YouTube Video hosting. URL: <https://youtu.be/uuVS4gkq5tE> (accessed on 29.11.2021).
17. Luhansk is destroyed. Part 4. Southern quarters. Photo [published on 25.07.2014] Ukr. Media website. URL: <https://ukr.media/ukrain/208023/> (accessed on 29.11.2021).
18. We remember! How Luhansk was shot. July 2014. LiveJournal Online Journal Service. URL: <https://kot-sapog.livejournal.com/9104932.html> (accessed on 29.11.2021).
19. Shelling of Luhansk on 14.07.2014. [published on 17.07.2014] YouTube Video hosting. URL: <https://youtu.be/4Xfm0453iVc> (accessed on 29.11.2021).

20. The shelling of Luhansk by the National Guard of Ukraine. Gayevoy residential quarter. 14.07.14. [published on 15.07.2014] YouTube Video hosting. URL: <https://youtu.be/V9nDgg4vbMM> (accessed on 29.11.2021).

21. Luhansk quarters - Mirny and Gayevoy fell under the GRAD. PHOTO. VIDEO [published on 15.07.2014] MigNews URL: <https://mignews.com.ua/sobitiya/inukraine/3242109.html> (accessed on 29.11.2021).

22. For a more detailed description of the characteristic shape of fastening of the BM-21 Grad rocket tail fins, see the investigation “Shelling of the city of Makeyevka with the use of BM-21 Grad multiple launch rocket systems on August 19, 2014”. URL: <https://lostarmour.info/articles/obstrel-goroda-makeevka-s-primeneniem-sistem-zalpovogo-ognya-bm-21-grad-19-avgusta-2014-goda/>

23. An attempt of the Armed Forces of Ukraine to break through into the Luhansk airport on July 13-14, 2014. YouTube Video hosting. URL: <https://youtu.be/MDETm1SgyYU> (accessed on 29.11.2021).

24. Territory nearby Gayevoy residential quarter, 14.07.2014. #Luhansk [published on 02.10.2014] VKontakte Social Network. URL: https://vk.com/wall-61706629_54204 (accessed on 29.11.2021).

25. Missilery in the exposition of the Military-Historical Museum of Artillery, Engineering Troops and Signal Corps (St. Petersburg). Part III. Missilery website. URL: <https://missilery.info/gallery/raketnaya-tehnika-v-ekspozicii-voenno-istoricheskogo-muzeya-artillerii-inzhenernyh-voysk-i-1> (accessed on 29.11.2021).

26. M-21OF 122 mm unguided high-explosive fragmentation projectile (ind. 9M22U) Rosoboronexport website. URL: <https://roe.ru/catalog/sukhoputnye-vosyka/boepripsy/m-21of/> (accessed on 29.11.2021).

27. “Grad” MLRS: history and performance characteristics. LiveJournal Online Journal Service. URL: <https://sobolev-sv.livejournal.com/535544.html> (accessed on 29.11.2021).

28. Summary reports from Igor Ivanovich Strelkov on July 14-15, 2014 [published on 15.07.2014] Top War Military Review website. URL:

<https://topwar.ru/54249-svodki-ot-strelkova-igorya-ivanovicha-14-15-iyulya-2014-goda.html> (accessed on 29.11.2021).

29. How many tanks are there in the Armed Forces of Ukraine? part 2. LiveJournal Online Journal Service. URL: <https://altyn73.livejournal.com/602318.html> (accessed on 29.11.2021).

30. The list of the dead. Google documents. URL: https://docs.google.com/spreadsheets/d/1IWV5AOyexGzrz1xCrP4H_Sj-Nvr3kKyq98CVKRo8XAA/edit#gid=306722867 (accessed on 29.11.2021).

31. The list of the dead. Google documents. URL: https://docs.google.com/spreadsheets/d/1IWV5AOyexGzrz1xCrP4H_Sj-Nvr3kKyq98CVKRo8XAA/edit#gid=306722867 (accessed on 29.11.2021).

32. 6, Stepnoy residential quarter. Wikimapia URL: <https://wikimapia.org/18850502/ru/%D0%A1%D1%82%D0%B5%D0%BF%D0%BD%D0%BE%D0%B9-%D0%BA%D0%B2%D0%B0%D1%80%D1%82%D0%B0%D0%BB-6> (accessed on 29.11.2021).

33. Those who look the death in the eye. Gorod URL: <https://www.gorod.cn.ua/news/gorod-i-region/59109-ti-hto-divitsja-smerti-v-ochi.html> (accessed on 29.11.2021).

Additional sources

34. Nikolay covered the stroller with the baby with his body. [published on 15.07.2014] VKontakte Social Network. URL: https://vk.com/wall-61706629?day=16072014&w=wall-61706629_57326 (accessed on 29.11.2021).

35. The enemy is actively using the Grad for shelling Mirny and Yuzhny [published on 14.07.2014] VKontakte Social Network. URL: https://vk.com/wall-61706629?day=14072014&w=wall-61706629_53535 (accessed on 29.11.2021).

36. The Militia has just responded to the Ukies with all their guns. Uragan and Grad. Revenge. [published on 14.07.2014] VKontakte Social Network. URL:

https://vk.com/wall-61706629?day=14072014&w=wall-61706629_53581 (accessed on 29.11.2021).

37. Salvos. Where to this time? [published on 14.07.2014] VKontakte Social Network. https://vk.com/wall-61706629?day=14072014&w=wall-61706629_53578 (accessed on 29.11.2021).

38. 14.07.14. Luhansk. The second shelling of residential quarters from Grad Fire. [published on 14.07.2014] YouTube Video hosting. URL: <https://youtu.be/8k8N5Y09Ebw> (accessed on 29.11.2021).

39. 14.07.14. Luhansk. The second shelling from Grad. [published on 14.07.2014] YouTube Video hosting. URL: <https://youtu.be/wFZvOSRde0w> (accessed on 29.11.2021).

40. 14.07.14. Luhansk. Shelling of the southern quarters from the Grad or catch a Ukrainian prezzy! [published on 14.07.2014] YouTube Video hosting. URL: <https://www.youtube.com/watch?v=IIeO2-mX9XY> (accessed on 29.11.2021).

41. 14.07.2014. Luhansk, Vtorchermet [published on 15.07.2014] VKontakte Social Network. URL: https://vk.com/video6930098_169464561 (accessed on 29.11.2021).

42. 14.07.2014. Luhansk. Shelling of Mirny residential quarter by death-squads, two persons killed (18+) | Ukraine, Luhansk [published on 14.07.2014] Rutube video hosting. URL: <https://rutube.ru/video/c38efd98063e2e5d2ba3f33d4486be86/> (accessed on 29.11.2021).

43. 14.07.2014. Luhansk. The result of shelling the city by death-squads from MLRS, Mirny residential quarter | Ukraine, Luhansk [published on 15.07.2014] Rutube video hosting URL: <https://rutube.ru/video/a10d24e87176257bd9f6cd98ce5cfd44/> (accessed on 29.11.2021).

44. M4H04685 [published on 14.07.2014] Odnoklassniki Social Network. URL: <https://ok.ru/video/5434770874> (accessed on 29.11.2021).

45. Shelling of Mirny residential quarter. Everyone should watch it. [published on 14.07.2014] VKontakte Social Network. URL: https://vk.com/wall-61706629?day=14072014&w=wall-61706629_53501 (accessed on 29.11.2021).

46. Grad 2 Parking lot. [published on 14.07.2014] YouTube Video hosting. URL: <https://youtu.be/1XCDtRIVM4A> (accessed on 29.11.2021).
47. Grad 2. 1, Linyova St. [published on 14.07.2014] YouTube Video hosting. URL: <https://youtu.be/Y4HzEPu1ALE> (accessed on 29.11.2021).
48. Grad 2. Linyova St. A rocket from Grad [published on 14.07.2014] YouTube Video hosting. URL: <https://youtu.be/e1TzriVAXt8> (accessed on 29.11.2021).
49. Mirny residential quarter in Luhansk came under artillery fire. 14.07.2014 [published on 14.07.2014] VKontakte Social Network. URL: https://vk.com/video69632707_169146273 (accessed on 29.11.2021).
50. How Luhansk was shot. July-2014 [published on 15.07.2014] YouTube Video hosting. URL: <https://youtu.be/mYEmo5LxwmE> (accessed on 29.11.2021).
51. City of #Luhansk. 16 Olkhovsky residential quarter [published on 14.07.2014] VKontakte Social Network. URL: https://vk.com/wall-61706629_54682 (accessed on 29.11.2021).
52. LUHANSK Vtorchermet after shelling by militants 2 14 07 2014 [published on 20.08.2014] YouTube Video hosting. URL: <https://youtu.be/AF-IMKGQzU8> (accessed on 29.11.2021).
53. Luhansk on 14.07.2014, Linyova St. Shelling with Grad (consequences) [published on 10.10.2014] VKontakte Social Network. URL: https://vk.com/video7456796_170241910 (accessed on 29.11.2021).
54. Luhansk 24. Projectiles on the roads of the city. July 14, 2014 [published on 14.07.2014] YouTube Video hosting. URL: <https://youtu.be/WdaWAr9SEsM> (accessed on 29.11.2021).
55. Luhansk 24. Shelling of Mirny residential quarter (18+) on July 14, 2014 [published on 14.07.2014] YouTube Video hosting. URL: <https://www.youtube.com/watch?v=iCoGEF59YSc> (accessed on 29.11.2021).
56. Luhansk 24. Shelling of the roundabout in Mirny residential quarter. July 14, 2014. Salda URL: <https://salda.ws/video.php?id=fTDZrvnP2Ok> (accessed on 29.11.2021).

57. Luhansk, the roundabout in Mirny residential quarter, 14.07.2014 [published on 14.07.2014] YouTube Video hosting. URL: <https://www.youtube.com/watch?v=mu-GHDfkrXw> (accessed on 29.11.2021).

58. Luhansk, shelling of the city with MLRS on 14.07.2014 [published on 14.07.2014] Odnoklassniki Social Network. URL: <https://ok.ru/video/202173845892> (accessed on 29.11.2021).

59. Luhansk, shelling with Grad system, 14.07.2014 [published on 15.07.2014] YouTube Video hosting. URL: <https://www.youtube.com/watch?v=7hq8Iup998w> (accessed on 29.11.2021).

60. Luhansk, effects of shelling of the city with MLRS by junta on 14.07.2014 [published on 15.07.2014] Odnoklassniki Social Network. URL: <https://ok.ru/video/12525308430> (accessed on 29.11.2021).

61. Luhansk today, Gayevoy residential quarter after the bombing! Ukraine, news today [published on 17.08.2014] YouTube Video hosting. URL: <https://youtu.be/UNdZ9s8Sn00> (accessed on 29.11.2021).

62. Luhansk, 14 07 2014 war, the roundabout in Mirny residential quarter [published on 14.07.2014] VKontakte Social Network. URL: https://vk.com/video-72945788_169610297 (accessed on 29.11.2021).

63. Mortar shelling of Mirny residential quarter on 14.07.2014. [published on 14.07.2014] YouTube Video hosting. URL: <https://www.youtube.com/watch?v=Um9Yla3dWXE> (accessed on 29.11.2021).

64. Shelling of Luhansk, Mirny, Olkhovsky, Stepnoy residential quarters, on 14.07.14, Karefan cafe and a parking lot [published on 15.07.2014] YouTube Video hosting. URL: <https://www.youtube.com/watch?v=4Vc4-AzTZcU> (accessed on 29.11.2021).

65. Shelling of Mirny residential quarter on 14.07.14 [published on 14.07.14] Odnoklassniki Social Network. URL: <https://ok.ru/video/5495260539> (accessed on 29.11.2021).

66. Effects of shellfire in Mirny residential quarter, Luhansk. [published on 14.07.14] YouTube Video hosting. URL: <https://www.youtube.com/watch?v=h45QDOd-3AI> (accessed on 29.11.2021).

67. Recorder 1 Mirny. [published on 14.07.2014] YouTube Video hosting. URL: <https://youtu.be/KillQqxsMBQ> (accessed on 29.11.2021).

68. Attack on Luhansk, Mirny residential quarter on 14.07. 18:55 [published on 14.07.2014] YouTube Video hosting. URL: <https://www.youtube.com/watch?v=faR8GVmfPH0> (accessed on 29.11.2021).

69. Attack on Luhansk, Mirny residential quarter on 14.07. 18:55 [published on 14.07.14] VKontakte Social Network. URL: https://vk.com/video168244023_169695833 (accessed on 29.11.2021).

70. Attack on residential quarters of #Luhansk with Grad. #Car parking space, 14.07.2014 [published on 14.07.2014] VKontakte Social Network. URL: https://vk.com/wall-61706629?day=14072014&w=wall-61706629_54691 (accessed on 29.11.2021).

71. Vtorchermet on 14.07 [published on 15.07.2014] VKontakte Social Network. URL: https://vk.com/video26081600_169806167 (accessed on 29.11.2021).

72. Gayevoy residential quarter 14.07.2014 [published on 15.07.2014] VKontakte Social Network. URL: https://vk.com/wall-61706629?day=15072014&w=wall-61706629_56552 (accessed on 29.11.2021).

73. Mirny, roundabout. VKontakte Social Network. https://vk.com/wall-61706629?day=14072014&z=video230925975_169501961%2Fd1afa2b55847fcc376%2Fpl_post_-61706629_53792 (accessed on 29.11.2021).

74. Another terrorist attack on Luhansk by the Ukrainian Armed Forces from the Grad MLRS on July 14, 2014. VKontakte Social Network. URL: https://vk.com/dapurification?w=wall-121569101_52421 (accessed on 29.11.2021).

75. Summary reports from Igor Strelkov and militia men on 14.07.2014 [published on 15.07.2014] News URL: <https://e-news.su/news/17486-svodka-sobytiy-ot-igorya-strelkova-i-opolchencev-14072014.html> (accessed on 29.11.2021).

76. Luhansk – another “victory” of the Ukrainian army [published on 16.07.2014] Forum-wec website. URL: <http://forum-wec.com/index.php?showtopic=236046&st=54850> (accessed on 29.11.2021).

77. Photo of the shelling [published on 14.07.2014] VKontakte Social Network. URL: https://vk.com/wall-61706629?day=14072014&z=album-61706629_199230649 (accessed on 29.11.2021).

78. City of #Luhansk, Mirny residential quarter, 14.07.2014 [published on 14.07.2014] VKontakte Social Network. URL: https://vk.com/wall-61706629?day=14072014&w=wall-61706629_54391 (accessed on 29.11.2021).

79. Apparently, they are hitting the ravine between the quarters... [published on 14.07.2014] VKontakte Social Network. URL: https://vk.com/wall-61706629?day=14072014&w=wall-61706629_53424 (accessed on 29.11.2021).

80. Peaceful residential quarters. #Luhansk [published on 14.07.2014] VKontakte Social Network. URL: https://vk.com/wall-61706629?day=14072014&w=wall-61706629_53512 (accessed on 29.11.2021).

81. View of Mirny quarter from the area near school No.33. #Luhansk [published on 14.07.2014] VKontakte Social Network. URL: https://vk.com/wall-61706629?day=14072014&w=wall-61706629_53482 (accessed on 29.11.2021).

ANNEXES

Annex 1

Attention! The data is entered through the form anonymously, we cannot guarantee the data accuracy. If you see the names of your family members, check through other sources.

You can add the information that is known by following the link <http://go.gl/pk1Qxs>

Time	Full name	Death site	Date of birth	If you do not know the exact date of birth, enter an approximate one	Date of death	How it happened
08.12.2014 18:46	Nikolai Bakhmach	Mirny residential quarter, Luhansk			14.07.2014	He was killed during the shelling of the Mirny quarter, covered a child with his body
8.16.2014 22:37:24	Sergei Petrovich Bober	Mirny residential quarter, in the vicinity of building No. 2, Luhansk	09.11.1958		14.07.2014	He walked from the bus stop (Mirny ring) toward building No. 1 in Mirny quarter. He did not reach about 50 meters to the entrance. Two metal fragments were removed from the body. He died from blood loss. He had not used his car for more than 2 weeks. Written by his son, Alexei Bober.
08.12.2014 18:42	Alla Logacheva	Mirny residential quarter, Luhansk	23.06.1976		14.07.2014	She was killed during the shelling of the Mirny quarter

Fig. 1 – Part of the list of the victims published on the Internet ¹⁵.



Fig. 2 - The scheme of shelling of the Mirny residential quarter, Luhansk, which happened on July 14, 2014 at about 18:00 (Moscow time).

¹⁵ The list of the dead. Google documents. URL: https://docs.google.com/spreadsheets/d/1IWW5AOyexGzrz1xCrP4H_Sj-Nvr3kKyq98CVKR08XAA/edit#gid=306722867 (accessed on 29.11.2021).



Fig. 3 - The scheme of shelling of the Gayevoy residential quarter, Luhansk, which happened on July 14, 2014 at about 18:00 (Moscow time).



Fig. 4 – The shell that fell between the building in 2, Mirny Kvartal, Luhansk, and the “Karefan” cafe¹⁶.

¹⁶ Luhansk on July, 14 2014. Shelling of the city with MLRS. Antimaydan website. URL: https://antimaydan.info/2018/07/Luhansk_14_iulya_2014_obstrel_goroda_iz_rszo.html (accessed on 29.11.2021).



Fig. 5 - The body of a man who was killed near the “Karefan” café¹⁷.



Fig. 6 – Burning cars in the parking lot, which is adjacent to the north side of the “Karefan” café after being hit by a projectile¹⁸.

¹⁷ LUHANSK AFTER THE SHELLING ON 14.07.2014. (VIDEO). [published on 16.07.2014] Liveinternet URL: <https://www.liveinternet.ru/users/natashinka57/post331058644/> (accessed on 29.11.2021).

¹⁸ Summary reports from Igor Ivanovich Strelkov on July 14-15, 2014 [published on 15.07.2014] Top War Military Review website. URL: <https://topwar.ru/54249-svodki-ot-strelkova-igorya-ivanovicha-14-15-iyulya-2014-goda.html> (accessed on 29.11.2021).



Fig. 7 – A shell hit on the northern wall of a multi-storey residential building at the address 6, Stepnoy quarter, Luhansk, at the fourth-floor level¹⁹.



Fig. 8 - A shell hit on the northern wall of a multi-storey residential building at the address 6, Stepnoy quarter, Luhansk, at the fourth-floor level²⁰.

¹⁹ Luhansk is destroyed. Part 4. Southern quarters. Photo [published on 25.07.2014] Ukr. Media website. URL: <https://ukr.media/ukrain/208023/> (accessed on 29.11.2021).

²⁰ 6, Stepnoy residential quarter. Wikimapia URL: <https://wikimapia.org/18850502/ru/%D0%A1%D1%82%D0%B5%D0%BF%D0%BD%D0%BE%D0%B9-%D0%BA%D0%B2%D0%B0%D1%80%D1%82%D0%B0%D0%BB-6> (accessed on 29.11.2021).



Fig. 9 – A hole formed as a result of the projectile-initiated detonation in the northern wall of a multi-storey residential building at the address 16, Olkhovsky quarter, Luhansk, at the second floor level²¹.



Fig. 10 - A hole formed as a result of the projectile-initiated detonation in the northern wall of a multi-storey residential building at the address 16, Olkhovsky quarter, Luhansk, at the second floor level²²

²¹ Luhansk, Olkhovsky residential quarter [published on 16.07.2014] Odnoklassniki Social Network. URL: <https://ok.ru/video/2331316729> (accessed on 29.11.2021).

²² Luhansk, 16, Olkhovsky residential quarter after shelling [published on 16.07.2014] Odnoklassniki Social Network. URL: <https://ok.ru/video/2331316729> (accessed on 29.11.2021).



Fig. 11 - A shell fragment found near the projectile detonation site beside the residential building at the address 16, Olkhovsky quarter, Luhansk²³.



Fig. 12 - Debris of the projectile missile part in the road pavement at the exit from Andrey Linyov Street, opposite the western end of the residential building at 79A, Andrey Linyov St, Luhansk²⁴.

²³ Luhansk, 16, Olkhovsky residential quarter after shelling [published on 16.07.2014] Odnoklassniki Social Network. URL: <https://ok.ru/video/2331316729> (accessed on 29.11.2021).

²⁴ The shelling of Luhansk by the National Guard of Ukraine. Gayevoy residential quarter. 14.07.14. [published on 15.07.2014] YouTube Video hosting. URL: <https://youtu.be/V9nDgg4vbMM> (accessed on 29.11.2021).



Fig. 13 - An artillery shell explosion crater on a lawn a few meters from the south-western corner of a multi-storey residential building at 79A, Andrey Linyov St, Luhansk²⁵.



Fig. 14 - Shell hit on the curb of the sidewalk between residential buildings at 85A, Andrey Linyov St. 81, Andrey Linyov St²⁶.

²⁵ The shelling of Luhansk by the National Guard of Ukraine. Gayevoy residential quarter. 14.07.14. [published on 15.07.2014] YouTube Video hosting. URL: <https://youtu.be/V9nDgg4vbMM> (accessed on 29.11.2021).

²⁶ Luhansk on 14.07.2014, Linyova St. Shelling with Grad (consequences) [published on 10.10.2014] VKontakte Social Network. URL: https://vk.com/video7456796_170241910 (accessed on 29.11.2021).



Fig. 15 - Debris of the projectile missile part a few meters north of the residential building at 79A, Andrey Linyov St., Luhansk between 1 and 2 entrance halls.²⁷



Fig. 16 – A crater in the yard of a multi-storey residential building at 79A, Andrey Linyov St., Luhansk, between 1 and 2 entrance halls²⁸.

²⁷ Luhansk on July, 14. Shelling of Vtorchermet 18+ [published on 15.07.2014] VKontakte Social Network. URL: https://vk.com/wall-61706629_57777 (accessed on 29.11.2021).

²⁸ Luhansk on July, 14. Shelling of Vtorchermet 18+ [published on 15.07.2014] VKontakte Social Network. URL: https://vk.com/wall-61706629_57777 (accessed on 29.11.2021).



Fig. 17 – A hole formed as a result of the projectile-initiated detonation in the northern wall of the two-storey residential building at 75L, Andrey Linyov St., Luhansk, at the level of the 1st floor.²⁹



Fig. 18 - A crater from the explosion of an artillery shell in a curb in the northern part of the road next to the “Vtorchermet” public transport stop, which is located to the south of the residential building at 77, Andrey Linyov St, Luhansk³⁰.

²⁹ Luhansk on July, 14. Shelling of Vtorchermet 18+ [published on 15.07.2014] VKontakte Social Network. URL: https://vk.com/wall-61706629_57777 (accessed on 29.11.2021).

³⁰ Luhansk on July, 14. Shelling of Vtorchermet 18+ [published on 15.07.2014] VKontakte Social Network. URL: https://vk.com/wall-61706629_57777 (accessed on 29.11.2021).



Fig. 19 - A crater from the explosion of an artillery shell in a curb in the northern part of the road next to the “Vtorchermet” public transport stop, which is located to the south of the residential building at 77, Andrey Linyov St, Luhansk³¹.



Fig. 20 – The body of a man who was killed at the “Vtorchermet” public transport stop located to the south of the residential building at 77, Andrey Linyov St., Luhansk³².

³¹ ##Luhansk. Home of Nature. (Between an agricultural farm and Gayevoy residential quarter [published on 14.07.2014] VKontakte Social Network. URL: https://vk.com/wall-61706629?day=14072014&w=wall-61706629_54059 (accessed on 29.11.2021).

³² #Luhansk. Home of Nature. (Between an agricultural farm and Gayevoy residential quarter [published on 14.07.2014] VKontakte Social Network. URL: https://vk.com/wall-61706629?day=14072014&w=wall-61706629_54059 (accessed on 29.11.2021).



Fig. 21 - A crater located 45 meters south of the south-east corner of the building at 75M, Andrey Linyov St., Luhansk³³.



Fig. 22 - Debris of the projectile missile part in the crater located 45 meters south of the south-east corner of the building at 75M, Andrey Linyov St., Luhansk³⁴.

³³ Luhansk on July, 14. Shelling of Vtorchermet 18+ [published on 15.07.2014] VKontakte Social Network. URL: https://vk.com/wall-61706629_57777 (accessed on 29.11.2021).

³⁴ Luhansk on July, 14. Shelling of Vtorchermet 18+ [published on 15.07.2014] VKontakte Social Network. URL: https://vk.com/wall-61706629_57777 (accessed on 29.11.2021).



Fig. 23 - The trail of a shell hit in the asphalt pavement nearby garages. A crater was formed 45 meters south of the south-east corner of the building at 75M, Andrey Linyov St., Luhansk, satellite image dated 16.07.2014.



Fig. 24 - A crater from the shell in the car parking to the west of the building at 3G Timiryazev St., Luhansk³⁵.

³⁵ Shelling of Luhansk on 14.07.2014. [published on 17.07.2014] YouTube Video hosting. URL: <https://youtu.be/4Xfm0453iVc> (accessed on 29.11.2021).



Fig. 25 – A crater from the shell in the car parking to the west of the building at 3GTimiryazev St., Luhansk³⁶.



Fig. 26 – A hole cut off as a result of the projectile detonation in the inner wall of the utility premises located to the north of the building at the address 75 lit Z, Andrey Linyov, Luhansk³⁷.

³⁶ Shelling of Luhansk on 14.07.2014. [published on 17.07.2014] YouTube Video hosting. URL: <https://youtu.be/4Xfm0453iVc> (accessed on 29.11.2021).

³⁷ Shelling of Luhansk on 14.07.2014. [published on 17.07.2014] YouTube Video hosting. URL: <https://youtu.be/4Xfm0453iVc> (accessed on 29.11.2021).



Fig. 27 – A hole broken by a projectile in the roof of the utility premises located to the north of the building at the address 75 lit. Z, Andrey Linyov St., Luhansk³⁸.



Fig. 28 – Trail of the shell hit into the roof of the utility premises located to the north of the building at the address 75 lit Z, Andrey Linyov St., Luhansk, satellite image dated 16.07.2014.

³⁸ Shelling of Luhansk on 14.07.2014. [published on 17.07.2014] YouTube Video hosting. URL: <https://youtu.be/4Xfm0453iVc> (accessed on 29.11.2021).



Fig. 29 - A shell explosion crater located about 25 meters from the south-western corner of the building at 3G, Timiryazev St., Luhansk³⁹.

³⁹ Territory nearby Gayevoy residential quarter, 14.07.2014. #Luhansk [published on 02.10.2014] VKontakte Social Network. URL: https://vk.com/wall-61706629_54204 (accessed on 29.11.2021).



Fig. 30 – Debris of the projectile missile part found near the crater located 25 meters from the south-western corner of the building at 3G, Timiryazev St., Luhansk ⁴⁰.



Fig. 31 – The shape of the holes for tail fin fastening which is typical for BM-21 “Grad” projectiles at the shell hit 12⁴¹.

⁴⁰ Gayevoy residential quarter, 14/07.2014. [published on 15.07.2014] VKontakte Social Network. URL: https://vk.com/wall-61706629?day=16072014&w=wall-61706629_56550 (accessed on 29.11.2021).

Luhansk on July, 14. Shelling of Vtorchermet 18+ [published on 15.07.2014] VKontakte Social Network. URL: https://vk.com/wall-61706629_57777 (accessed on 29.11.2021).

⁴¹ Shelling of Luhansk on 14.07.2014. [published on 17.07.2014] YouTube Video hosting. URL: <https://youtu.be/4Xfm0453iVc> (accessed on 29.11.2021).



Fig. 32 - The shape of the holes for tail fin fastening which is typical for BM-21 “Grad” projectiles at the shell hit 13⁴².

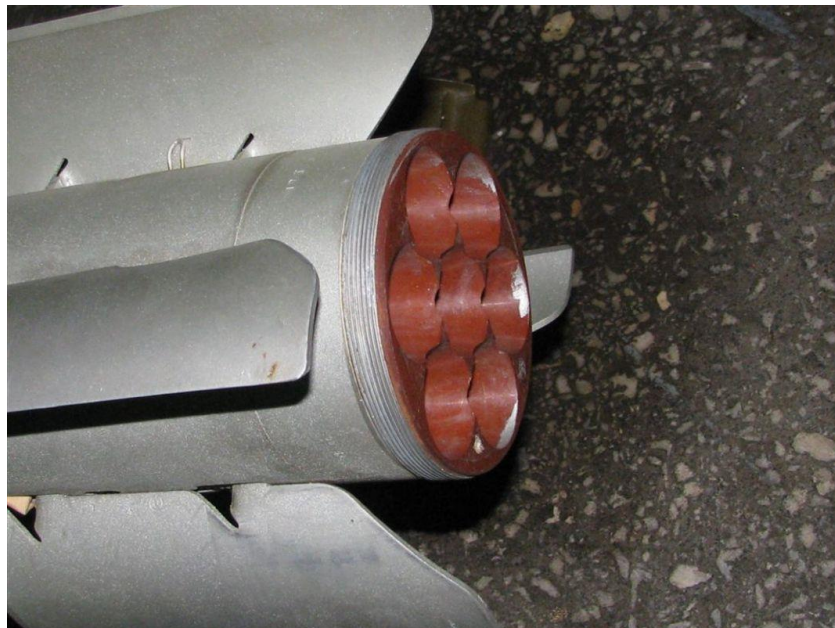

Fig. 33 – View of the stabilizer block and the nozzle block cross-section of the of the 9M22M unguided rocket projectile model⁴³.

⁴² Shelling of Luhansk on 14.07.2014. [published on 17.07.2014] YouTube Video hosting. URL: <https://youtu.be/4Xfm0453iVc> (accessed on 29.11.2021).

⁴³ Missilery in the exposition of the Military-Historical Museum of Artillery, Engineering Troops and Signal Corps (St. Petersburg). Part III. Missilery website. URL: <https://missilery.info/gallery/raketnaya-tehnika-v-ekspozicii-voenno-istoricheskogo-muzeya-artillerii-inzhenernyh-voysk-i-1> (accessed on 29.11.2021).

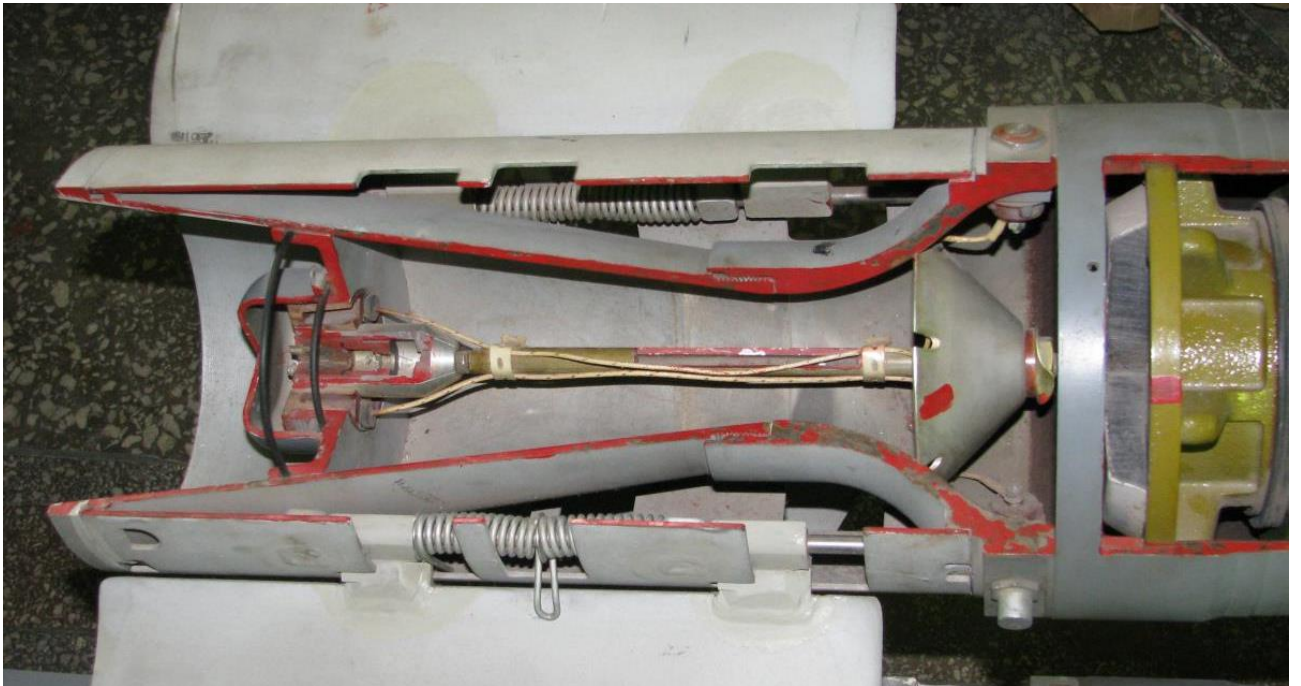

Fig. 34 – Section view of the missile part nozzle of the BM 27 Uragan MLRS rocket projectile⁴⁴.

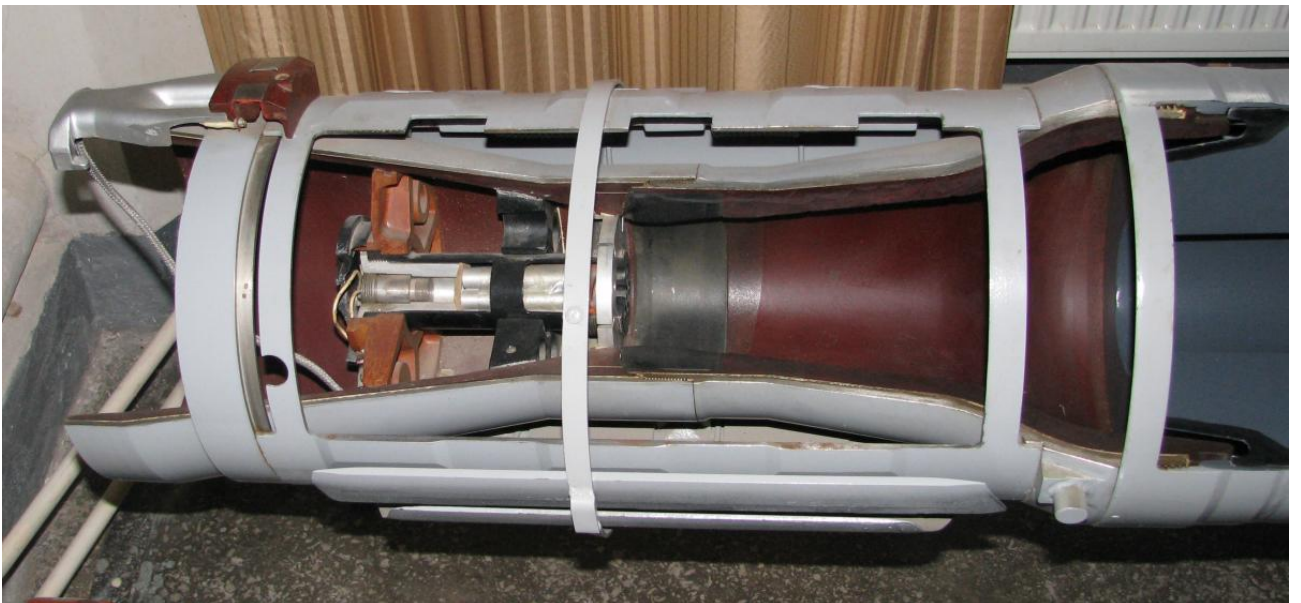

Fig. 35 – Section view of the missile part nozzle of the "Smerch" (Whirlwind) MLRS rocket projectile⁴⁵.

⁴⁴ Rocket Artillery Munitions. Missilery website. URL: <https://missilery.info/article/ram> (accessed on 29.11.2021).

⁴⁵ Rocket Artillery Munitions. Missilery website. URL: <https://missilery.info/article/ram> (accessed on 29.11.2021).

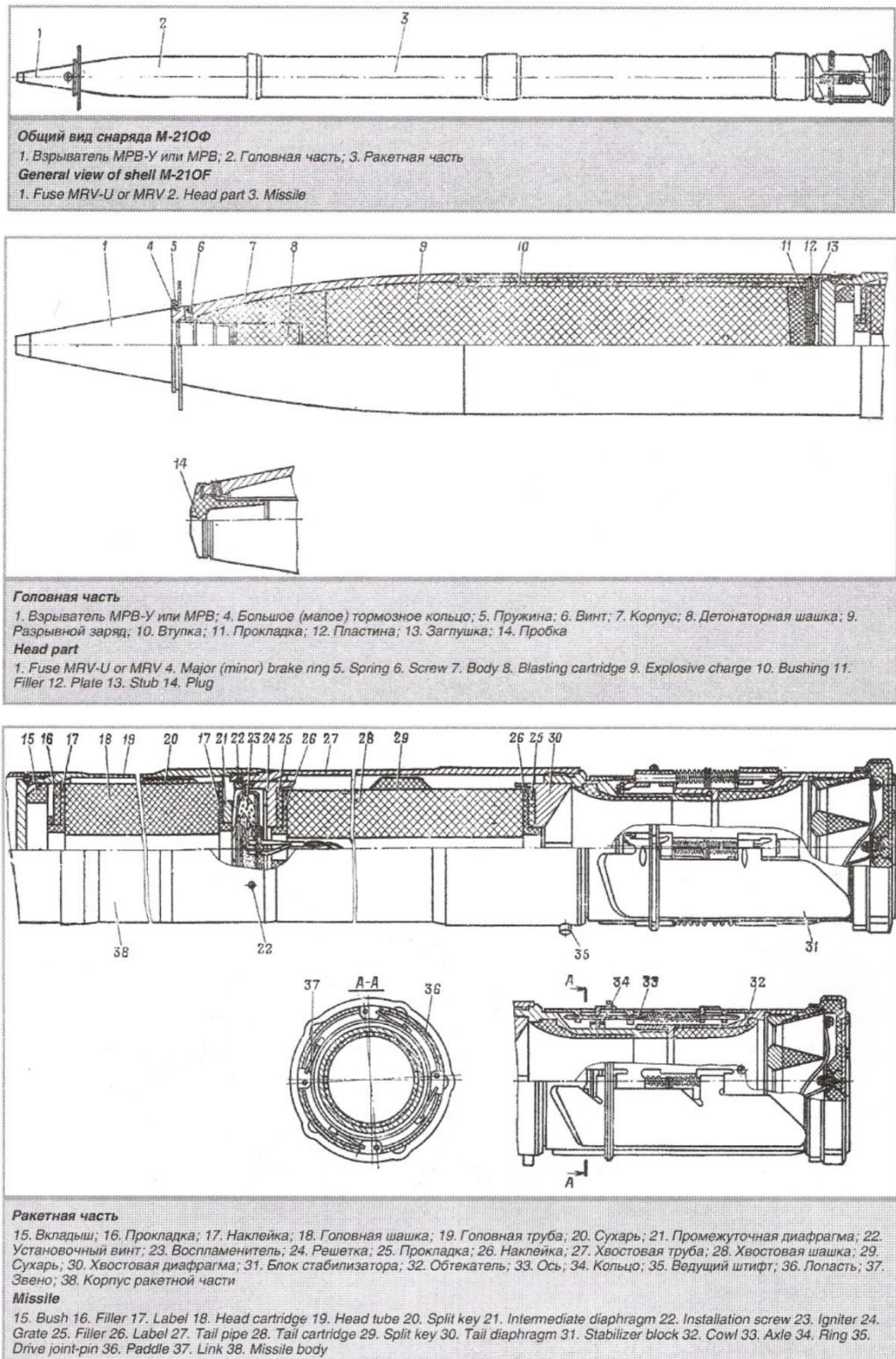

Fig. 36 - M-21OF projectile design (a high explosive fragmentation projectile, used for firing from 9K51 Grad MLRS)⁴⁶.

⁴⁶ Gun in Russia – BM-21 GRAD. Russian motor books 2002. 37 p.

Caliber, mm	122
Projectile length with fuse, mm	2870
Warhead type	high-explosive fragmentation
Weight, kg:	
- finally equipped projectile	66
- capped shell	100
- warhead	18.4
- warhead explosive	6.4
- powder charge	20.45
maximum projectile speed under normal conditions, m/s	690
firing range, m	
- maximum	20400
- with large locking ring	up to 12000
- with small locking ring	from 12500 to 16000
Temperature range for projectile application °C	-40 - +50
overall cap dimensions, mm	2810x290x254

Fig. 37 - Technical characteristics of the unguided M-21OF rocket projectile M-21OΦ⁴⁷.



Fig. 38 – The fragment scattering pattern (shell hit 4)⁴⁸.

⁴⁷ Mechanized combat vehicle BM-21. Technical description. Book 1. Moscow: Voenizdat, 1971. Pp. 7, 8, 91; Mechanized combat vehicle BM-21. Technical description and operating instructions manual. 3rd edn., stereotyped. Moscow: Armament. Politics. Conversion, 2002. Pp. 5-6.

⁴⁸ Luhansk, 16, Olkhovsky residential quarter after shelling [published on 16.07.2014] Odnoklassniki Social Network. URL: <https://ok.ru/video/2331316729> (accessed on 29.11.2021).

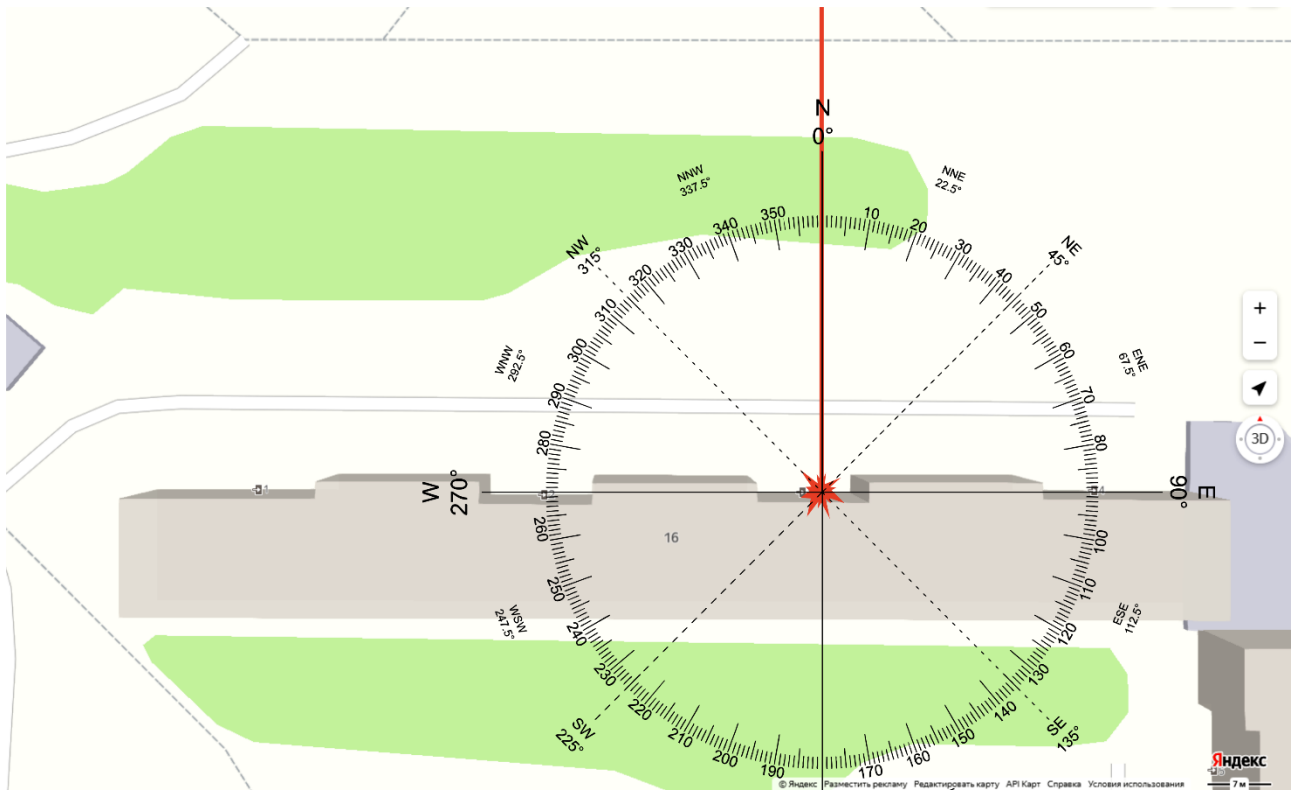

Fig. 39 – Shelling direction in the case of shell hit 4.

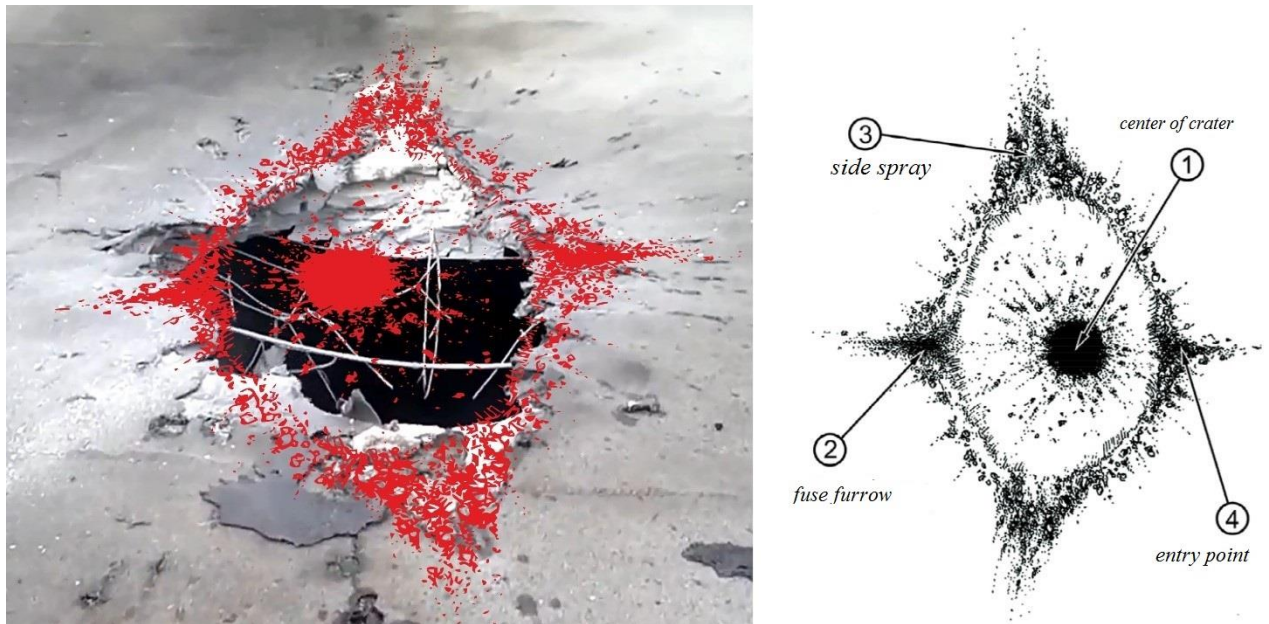

Fig. 40 – Clear trail shape in case of shell hit 13⁴⁹.

⁴⁹ Shelling of Luhansk on 14.07.2014. [published on 17.07.2014] YouTube Video hosting. URL: <https://youtu.be/4Xfm0453iVc> (accessed on 29.11.2021).

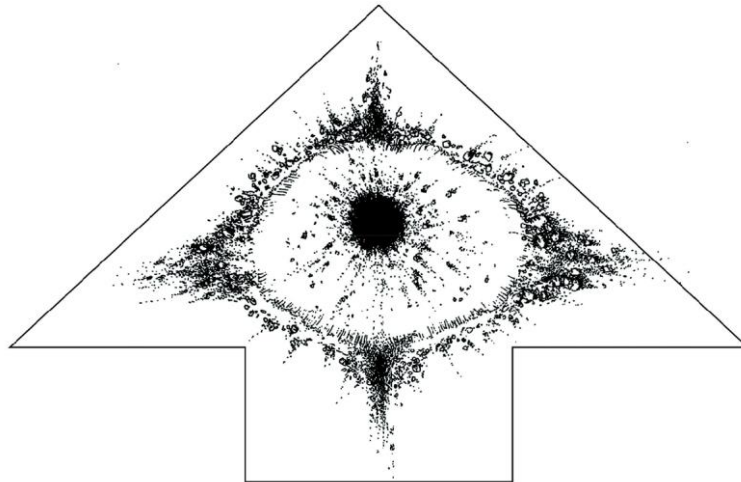

Fig. 41 – Form of the shell crater resulting from contact with the surface at a low striking angle without delayed detonation makes it possible to determine the shelling direction⁵⁰.



Fig. 42 – Fire direction determination using satellite imagery dated 16.07.2014 (shell hit 13).

⁵⁰ High-explosive fragmentation shell crater analysis. "Fair Defense" Public Organization. URL: <https://oosz.su/node/42> (accessed on 27.11.2021).



Fig. 43 – Shell hit 10: trail from the main scatter of fragments on the north side of the curb⁵¹.

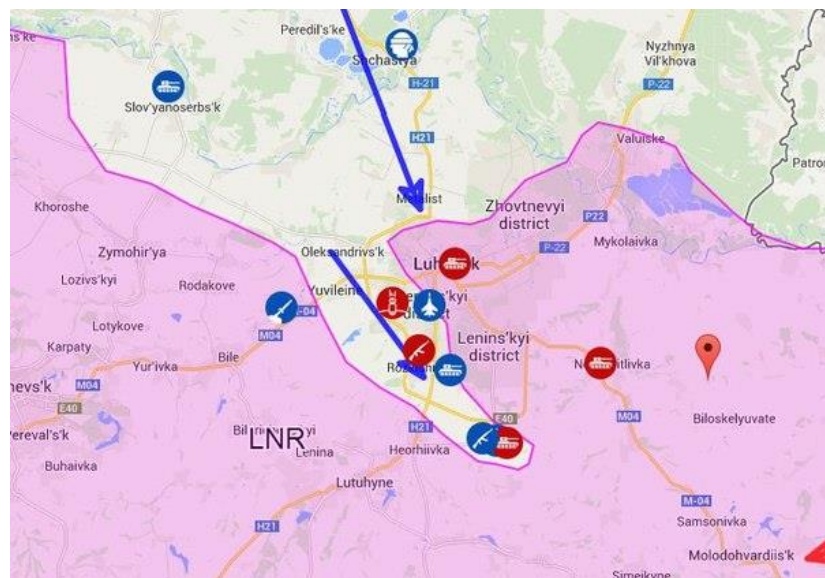

Fig. 44 – Map of the attempt to unblock the Luhansk airport on July 13-14, 2014.

⁵¹ Luhansk on July, 14. Shelling of Vtorchermet 18+ [published on 15.07.2014] VKontakte Social Network. URL: https://vk.com/wall-61706629_57777 (accessed on 29.11.2021).

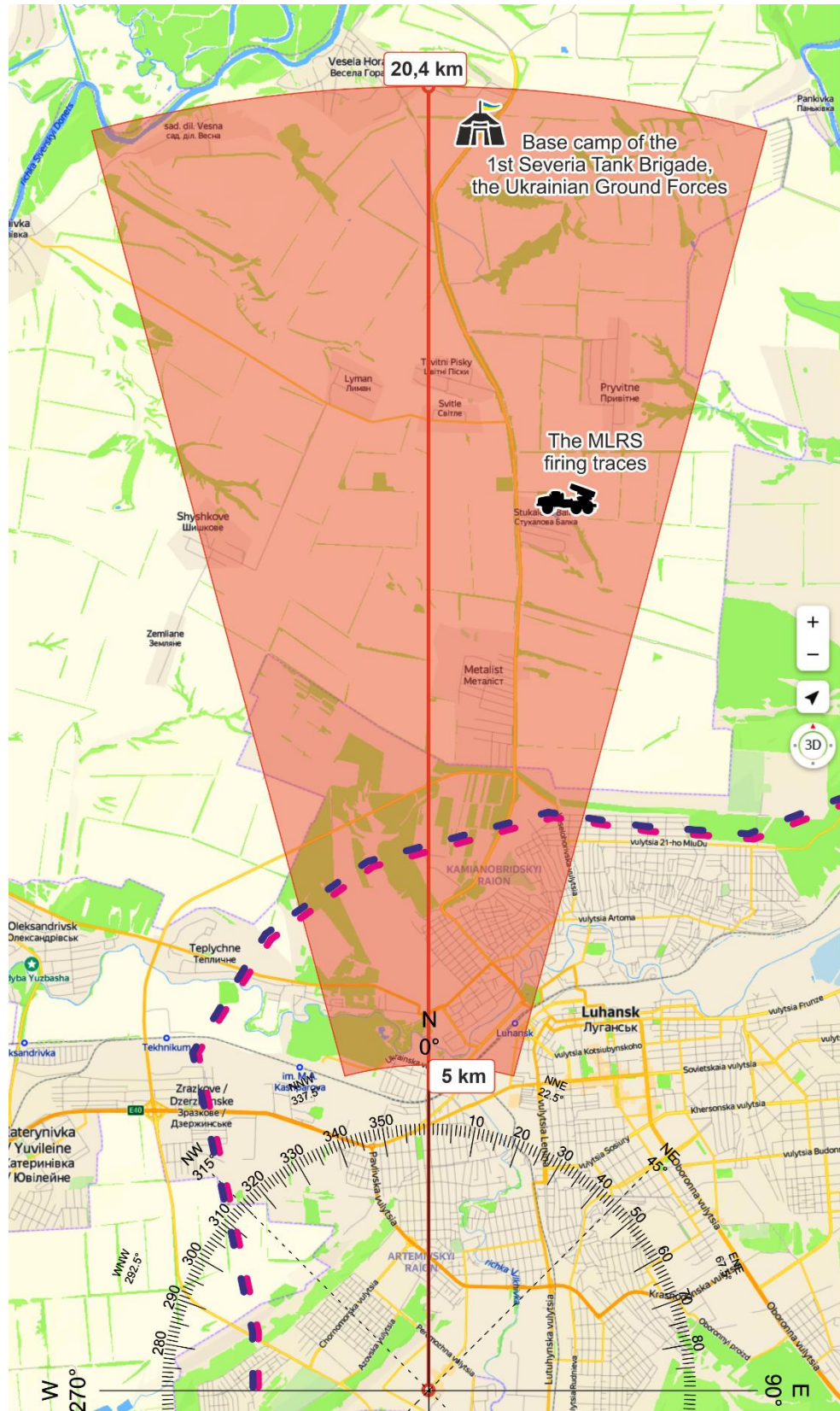

Fig. 45 – The sector from which the shelling of the city of Luhansk was carried out on July 14, 2014.



Fig. 46 – Base camp of the 1st Tank Brigade in the vicinity of Veselaya Gora settlement in the satellite image dated 17.07.2014.



Fig. 47 – Ukrainian BM-21 Grad MLRS are firing in the direction of Luhansk from positions in the vicinity of Veselaya Gora settlement.



Fig. 48 – Patches of burnt earth and traces of military equipment movement towards these patches from the north of Stukalova Balka settlement (satellite image dated 17.07.2014).

1st Severia Tank Brigade	
Ukrainian: 1-ша окрема танкова бригада	
	
1st Tank Brigade shoulder sleeve patch	
Active	1992
Country	 Ukraine
Branch	 Ground Forces
Type	 Armored Forces
Size	Brigade
Part	 of North Operational
Garrison	 HQ Chernigov Region, Honcharivske settlement
Engagements	Russian armed aggression against Ukraine <ul style="list-style-type: none"> • War in the East of Ukraine <ul style="list-style-type: none"> • Lutansk Airport • Donetsk Airport • Battle in Piski • Battle in Debaltseve
Honorific	Sivierska

Fig. 49 – Brief information about the 1st Tank Brigade (Ukraine) from the Ukrainian version of Wikipedia⁵².



Fig. 50 – Commander of the 1st Severia Tank Brigade of the Ukrainian Ground Forces Colonel Andrey Nikolaevych Gritskov, born in 1972.⁵³

⁵² 11. 1st Tank Brigade (Ukraine). Wikipedia. [https://en.wikipedia.org/wiki/1st_Tank_Brigade_\(Ukraine\)](https://en.wikipedia.org/wiki/1st_Tank_Brigade_(Ukraine)) (accessed on 29.11.2021).

⁵³ How many tanks are there in the Armed Forces of Ukraine? part 2. LiveJournal Online Journal Service. URL: <https://altyn73.livejournal.com/602318.html> (accessed on 29/11/2021); <https://web.archive.org/web/20170714050905/http://monitor.cn.ua:80/ua/characters/HrytskovAndriyMykolayovych>



Fig. 51 – The 1st Tank Brigade operating platoon commander Lieutenant Chepiga.



Fig. 52 – Servicemen of the 1st Severia Tank Brigade involved in the shooting from the Grad MLRS.